



multi edge

multi edge

SMART GARDEN
EDGING SOLUTIONS

multi edge



METAL
ADVANCE
FLEX
ECO

For every edging situation a **solution**

Discover the endless possibilities of Multi-Edge lawn edging. Using lawn edging in your garden creates a stylish look. Lawn edging also offer many practical advantages. It limits weed growth, ensures that gravel or chippings stay in the right place and keeps the edges of your lawn neat all year long.

Multi-Edge lawn edging are designed by our design department and are produced in Europe with durability and quality as our highest priority. The range of edgings is adapted to your garden wishes and can be easily customised. And with the wide choice of colours and materials, there is always a Multi-Edge lawn edging available for your garden.

Multi-Edge METAL

Stylish edges in your garden

Multi-Edge METAL lawn edging makes it easy to create stylish edges with any desired contour, whether you want a winding gravel garden path or neat lawn edges along a border. A choice of 5 finishes means that you can always find just the right one for the look you want.

- ✔ High quality (1.5 mm thick steel)
- ✔ Long lifespan
- ✔ Recyclable
- ✔ Easy to install without pins or bolts

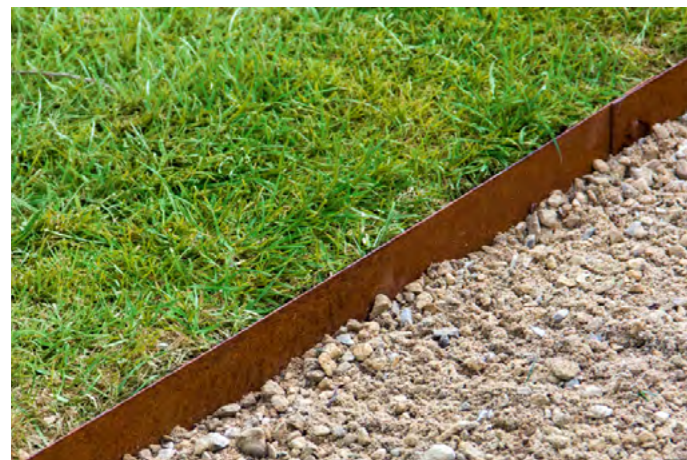

Edge protection

Are you installing the Multi-Edge METAL in a place where people or pets can step or fall on the edging? If so, you can optionally choose for a protective strip that can be clamped around the edging. This reduces the risk of accidents to a minimum and makes you feel safe!

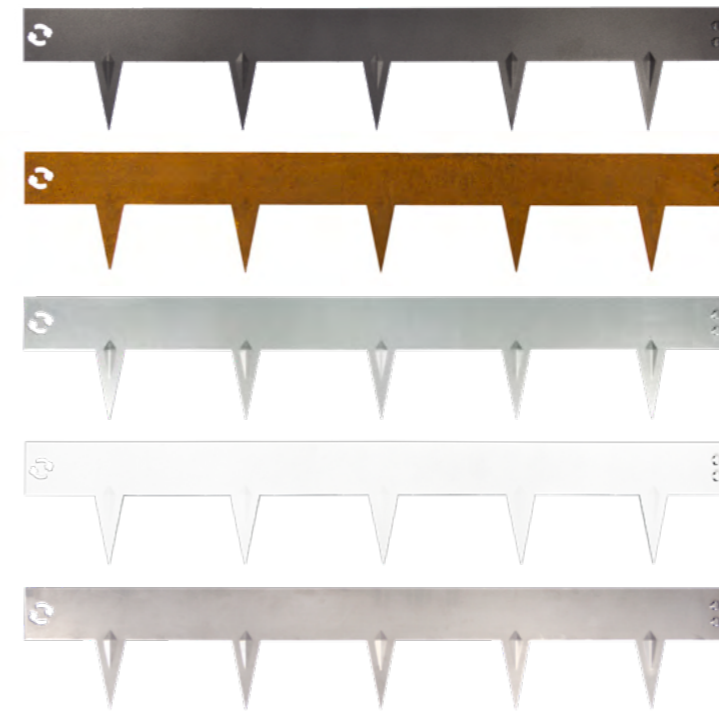

Your choice of finishes

Multi-Edge METAL is available in five finishes:

- Black coated
- Corten steel
- Galvanised
- White coated
- Stainless steel

Installation

With the interconnecting system of the Multi-Edge METAL, you can connect the edgings to each other in one movement. You can easily bend the edging into curved or round shapes. For optimal stability, allow a maximum of 4cm of the edging to protrude above the ground.

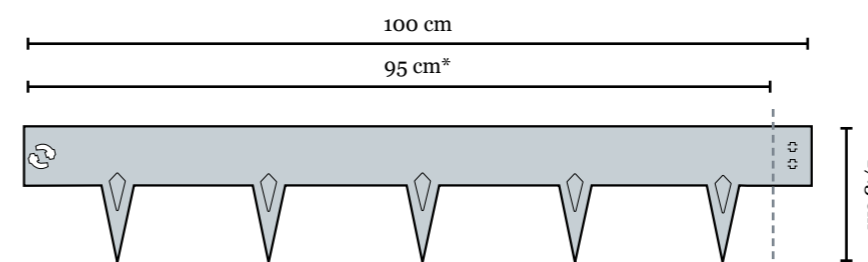
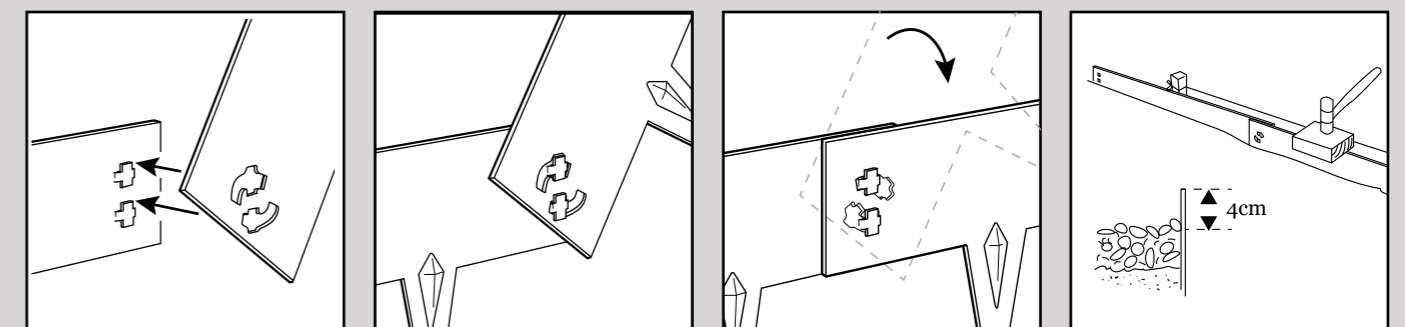

*working length. To calculate how many segments you need for the total required length you have to edge, divide this length by 0.95.

Multi-Edge ADVANCE

Advanced edging system designed to be seen



Multi-Edge ADVANCE is a high-quality edging system for lawns, borders and gravel areas, for example. The unique smart interconnecting system uses connector strips to connect the profiles and are secured by means of fixing stakes, creating a harmonious and smooth transition between profiles. Multi-Edge ADVANCE segments are 1 mm thick and have a 3 mm fold at the top and bottom, giving the system an attractive and solid feel and ensuring that the profiles are still easy to install if they have been bent to form a curved shape. Multi-Edge ADVANCE is available in galvanised and Corten Steel.

- ✔ High-quality profiles 20 cm high
- ✔ Stable and lightweight
- ✔ Interconnecting system invisible after installation



Available in galvanised and Corten Steel

Profiles can be left straight or bent to form a curved shape

Unique interconnecting system allows each fixing stake to be attached in any chosen position

Stabile and visible

When installed as edging for lawns, borders and gravel areas, up to 10 cm of the profile can be left visible above the surface of the soil.

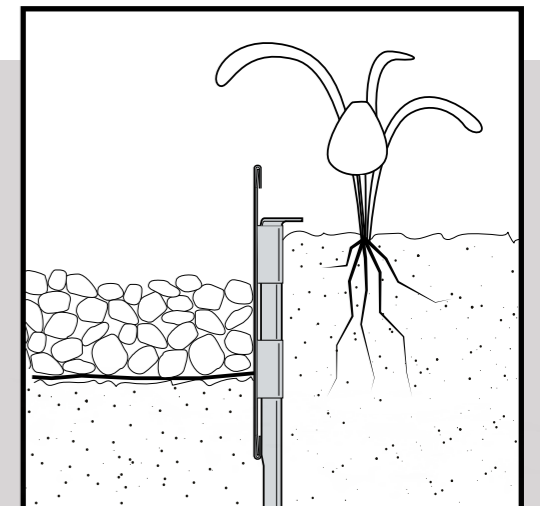

A superb finish for any application

The folded top and bottom edges of the profile give the edging a stable and solid feel. The unique feature of Multi-Edge ADVANCE is that the connector strips and fixing stake are not seen on the visible side of the edging. The smart interconnecting system ensures that the ends of the profiles fit together perfectly. The profiles are easy to bend.



Corners

For extra tight 90-degree angles, use the optional corner pieces. These are connected to the edging with the connection set. This way you can create the most beautiful border edges or edging around trees in no-time!

Installation

Fixing stakes are attached to the profile, ensuring the stability of the installed edging. You can attach them wherever you choose! You push a connector strip underneath the top and bottom edge of the profile, press it against the profile and then insert the fixing stake. This handy method also makes the profiles easy to connect together.

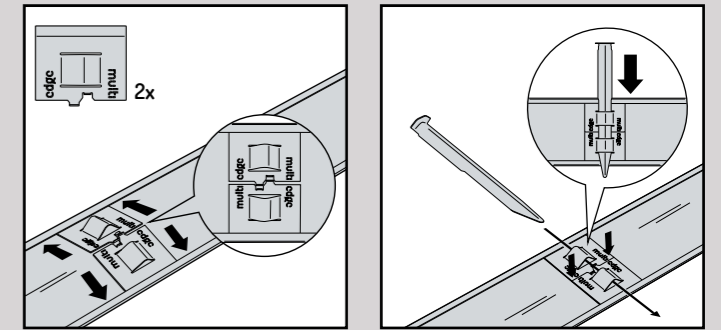

Profile

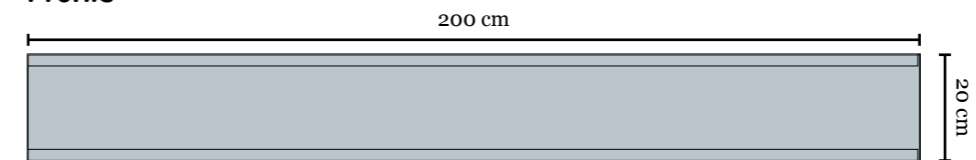

Connection set

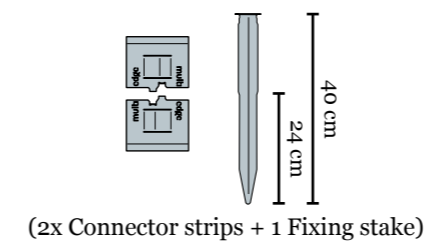

Corner piece

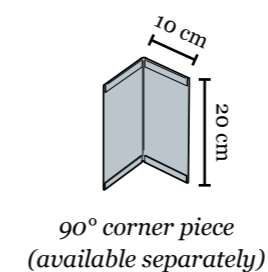

Each 2-metre profile comes with 3 connection sets.

Each corner piece comes with 1 connection set.

Colors

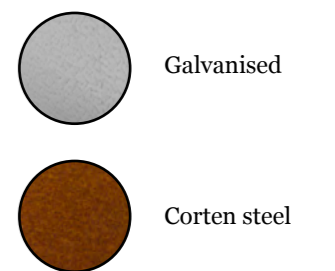

Multi-Edge FLEX

Quick and easy garden edging for any contour!

Multi-Edge FLEX is a flexible edging made from recycled plastic. This is a simple way to keep the edges in your garden neat and tidy. The smart construction makes it easy to create both straight and curved contours. Whether it is for a plant border, lawn, gravel path or patio, Multi-Edge FLEX is an beneficial and very versatile solution.

- ✔ For straight and curved contours
- ✔ Stable and flexible
- ✔ Very versatile
- ✔ Available in two heights

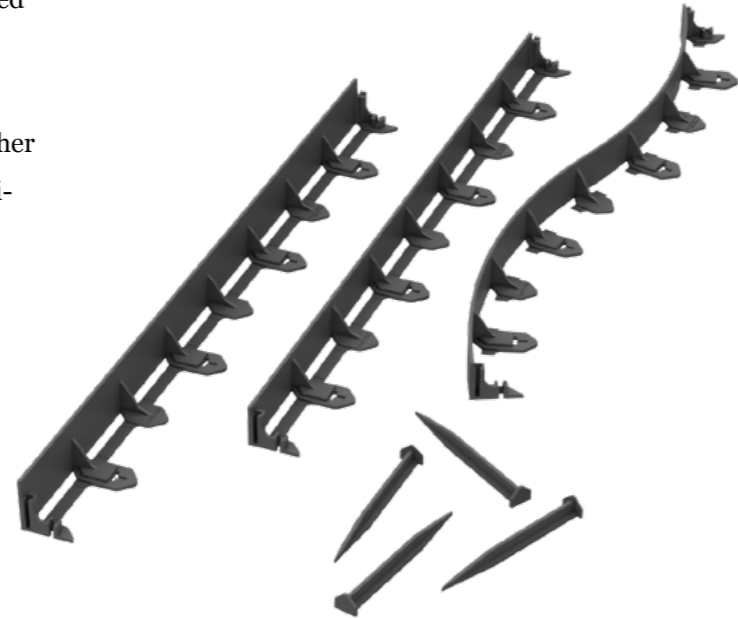

One product - so many uses

Multi-Edge FLEX has a unique construction unlike any other garden edging products. This is what makes it possible to create both straight edges and curved winding contours. Depending on the application you can choose from two available heights.

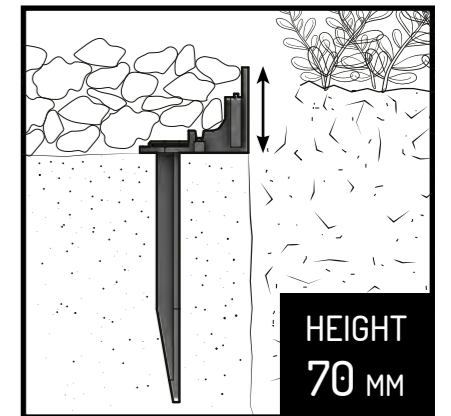
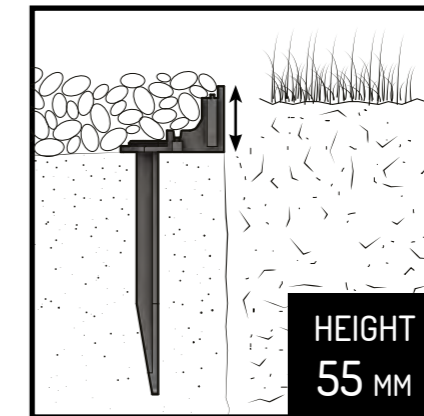

Easy installation

By cutting connecting pieces out of the edging, the Multi-Edge FLEX can be used to create curves, round shapes and corners.

With the smart interconnecting system you can easily connect the sections. The supplied ground pegs are used to secure the edging.

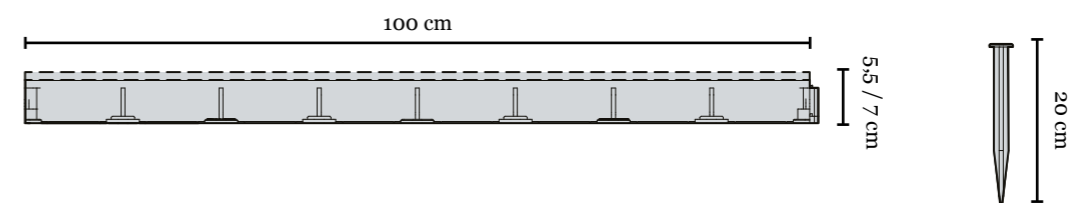
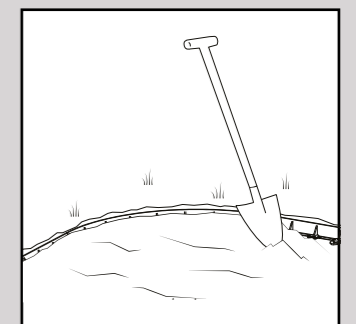
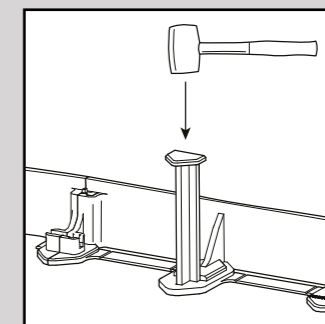
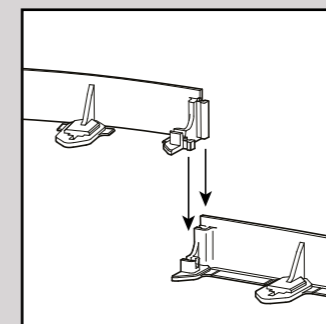
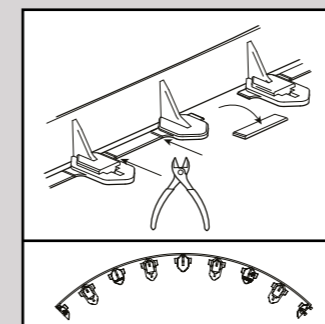
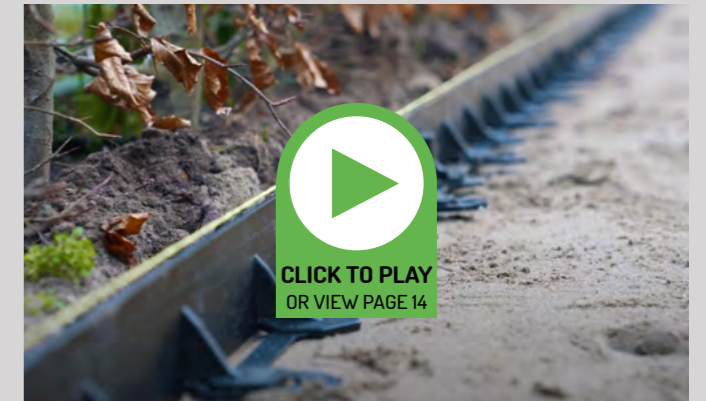

Each 1-metre edging section is supplied with 4 pegs.

Multi-Edge ECO

Sustainable and attractive: a versatile edging

Multi-Edge ECO is a series of edgings made from 100% recycled plastic. With a choice of rolls and straight parts in a range of colours, the Multi-Edge ECO always offers a suitable solution for your garden. The edging contains small pieces of plastic packaging, giving it its unique rough texture and natural appearance. Multi-Edge ECO therefore combines the best of both worlds.

- ✔ Available in a range of sizes
- ✔ Natural appearance
- ✔ Easy to install
- ✔ Sustainable choice



A solution for every application

The Multi-Edge ECO is available on a roll for curved or round edgings. Ideal for areas around trees, pond edges and curved borders etc. Or choose straight parts to create straight borders, grass edges or to finish a straight path or driveway. Depending on the application, there is a range of heights to choose from. Choose a lower edging that is less visible or a higher edging to compensate for small differences in height, for example.

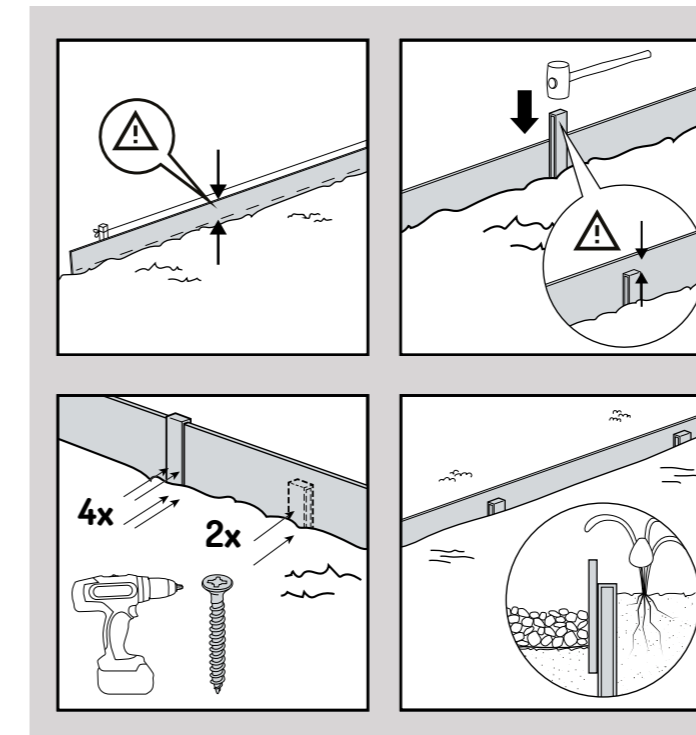

Installation

The Multi-Edge ECO can be installed in almost any desired shape. You can cut the edging by using a hand saw. Stabilise the edging with separate available fixing stakes that can be secured to the edging at any desired location. The fixing stakes can also be used to cover the gap between the sections.

[CLICK TO DOWNLOAD INSTRUCTIONS](#)
OR VIEW PAGE 14

Straight parts

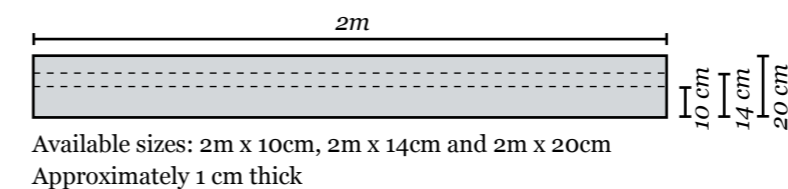

Rolls

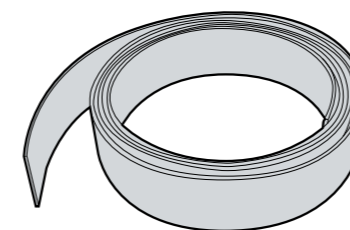

Available sizes:
10m x 10cm
10m x 14cm
10m x 20cm
20m x 10cm
20m x 14cm
20m x 20cm
Approximately 1 cm thick

Fixing stakes

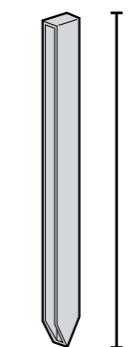

Colors

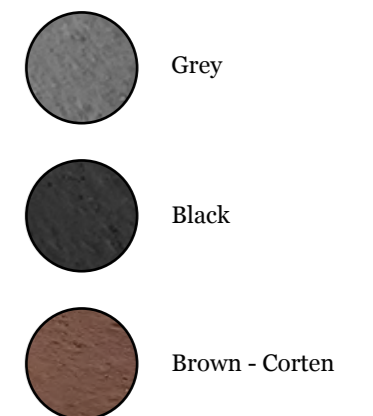

Installation instructions



Multi-Edge METAL

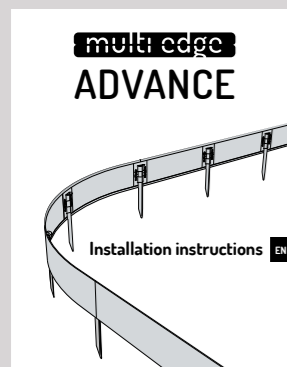
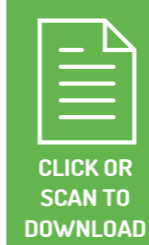
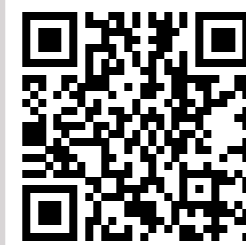

Multi-Edge ADVANCE

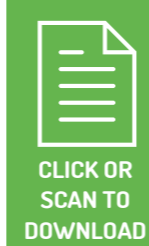
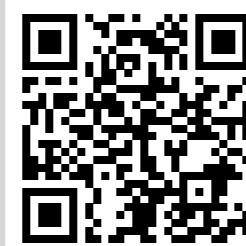

Multi-Edge FLEX

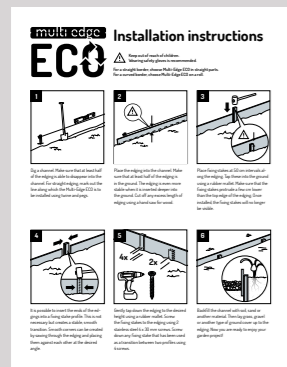
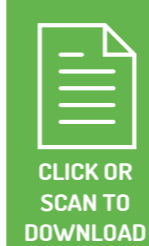
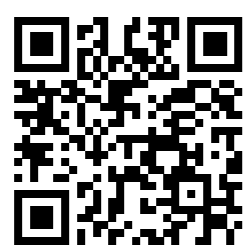

Multi-Edge ECO

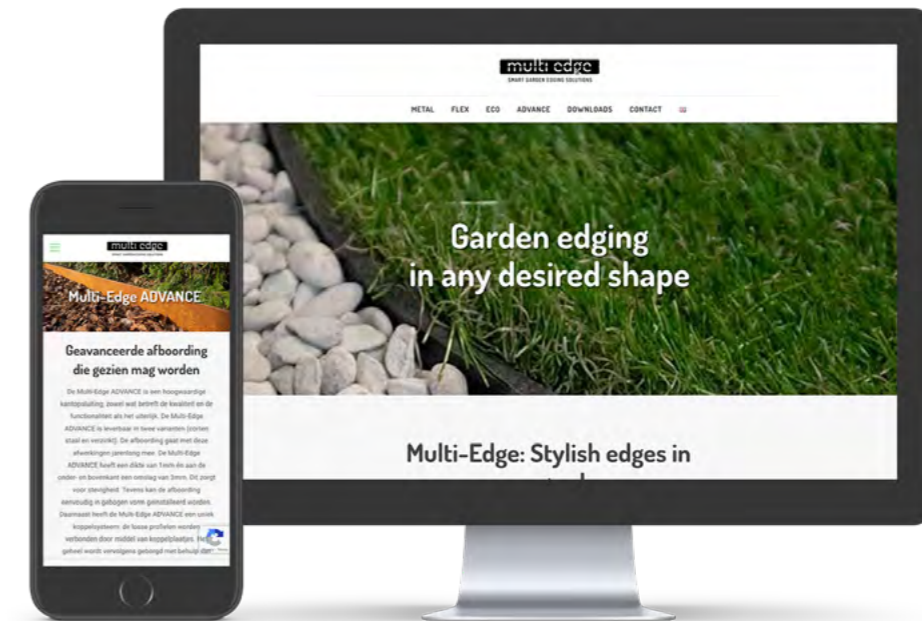
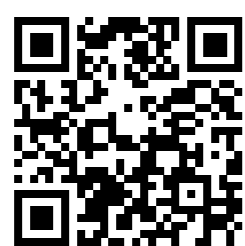

Visit [Multi-edge.com](https://www.multi-edge.com)

For more product information and contact details



multi edge

multi

multi edge

Multi-Edge.com